

Specification sheet LX 2266

Balcony Drainage Balcony Drain Series V-FL

Main drainage	
Gravity flow	
Silent	
Discharge rate:	1,35 l/s
Water height:	35 mm
Roof penetration:	-
Diameter:	DN 50
LX-Number:	LX 2266
Weir height:	0 mm
Drain:	ventilated
Downpipe:	not ventilated
Downpipe height:	2,75 m
Drainage:	into ground pipe

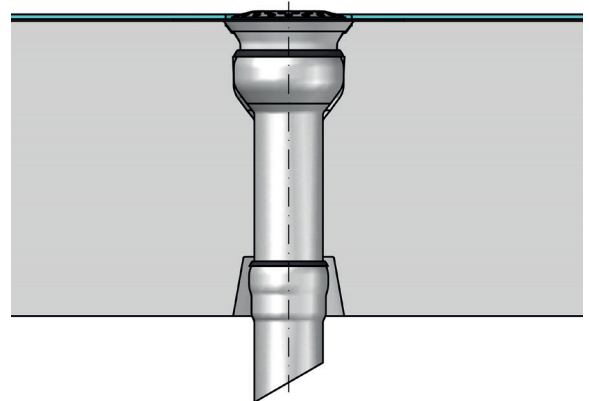

LX 2266 Piece list
Choose setup elements and extension cartridge on page 2!

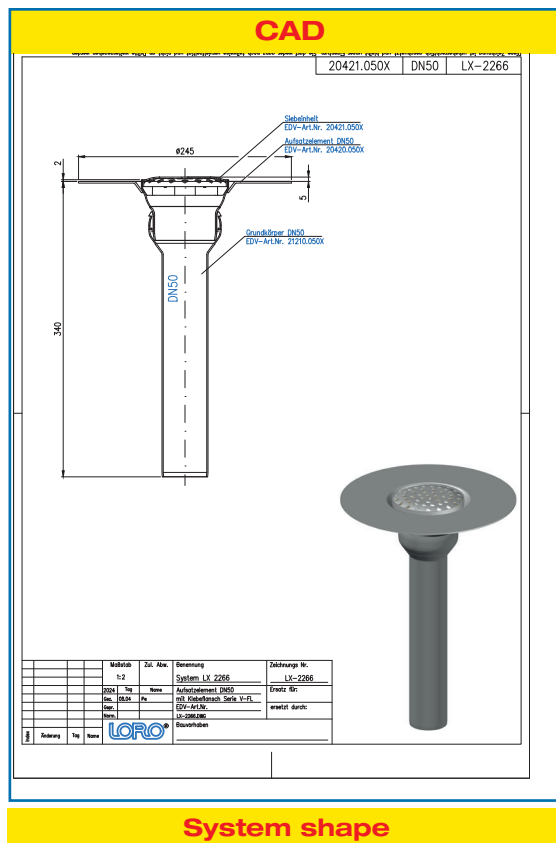
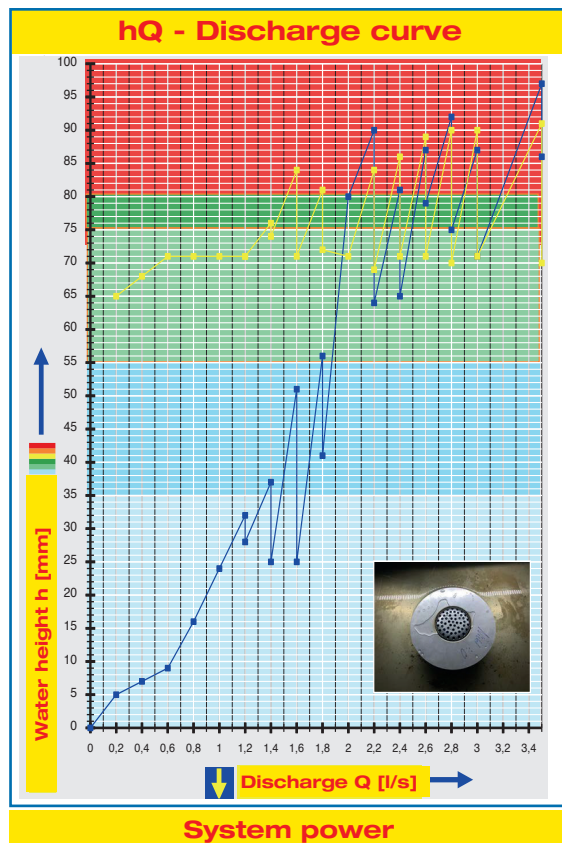

Water height	mm	5	10	15	20	25	30	35	40	45	50	55	60	65	70	75	80
Discharge	l/s	0,20	0,62	0,77	1,0	1,02	1,15	1,35	1,51	1,55	1,59	1,79	1,9	1,93	1,95	1,99	2,0
Silent																	

Please choose suitable setup elements and an extension cartridge!

DN 50

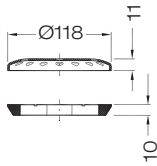

Strainer unit

consisting of: strainer, round, **without** pipe penetration, support ring

Art.-No. 20422.050X

Weight: 0,15 kg

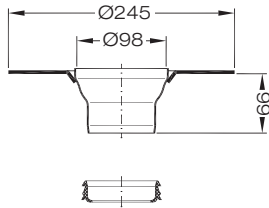

one-piece version

LX2266-12X

Setup element, Series V-FL

with bonding flange, for sealing made of liquid plastic, made of stainless steel

Art.-No. 20420.050X

Weight: 1,05 kg

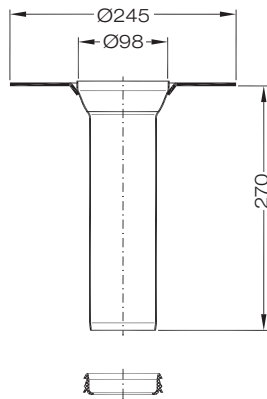

two-piece version

LX2266-13X

Extension unit

for thermally insulated balconies, **Series V-FL** with bonding flange, for sealing made of liquid plastic, consisting of: extension unit with bonding flange, sealing element DN 70

Art.-No. 20425.050X

Weight: 1,8 kg

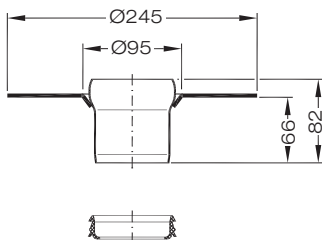

Setup element with socket

for thermally insulated balconies, **Series V-FL** with bonding flange, for sealing made of liquid plastic

Art.-No. 20426.050X

Weight: 1,0 kg

Base unit

Art.-No. 21400.050X
consisting of:



① **Formwork mushroom**

Art.-No. 18110.050X

② **Base body**

Art.-No. 21210.050X

③ **Formwork dome**

Art.-No. 18100.050X

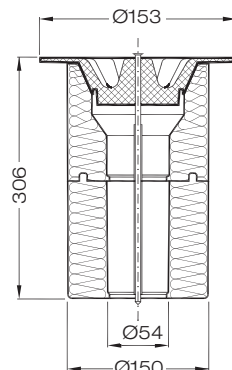

Thermal insulation base unit

consisting of: formwork mushroom, thermal insulation body and fastening screw

Art.-No. 21401.050X

Weight: 0,7 kg

Attention:

The base body 21210.050X has to be ordered separately!